

CITY



Lavabi / Washbasins	
100x50, 80x50, 60x50	p.316
80x50, 80x50	p.318
64x48, 58x45	p.320
61x52, 57x47	p.322
57x42	p.324
<hr/>	
Wc e Bidet / Wc and Bidet	
52x35	p.326
52x35F, 52x35	p.328
48x35	p.330

**La rinnovata collezione basic di GSI si declina in due linee di lavabi installabili a sospensione, su colonna anch'essa in ceramica, oppure su mobili e piani, e altrettante tipologie di sanitari disponibili per installazione a pavimento o a sospensione. I lavabi City sono estremamente versatili per le loro forme semplici, stondate o rettangolari, incorporando alcuni modelli dotabili di portasciugamano cromato, e la molteplicità dei sistemi di installazione. I sanitari City sono disponibili con copriwater sottili ad estrazione rapida Quick Release e con sistema di chiusura Soft Close, adottano il sistema di scarico Save Water a 4,5 litri.**

This updated basic GSI collection comes in two lines of washbasins that can be installed into walls, on a column which is itself ceramic, or on mobile supports and countertops. The collection also offers two types of sanitary elements available for installation on the floor or on the wall. City washbasins are extremely versatile because of their simple rectangular and rounded shapes, including several models that can be equipped with chromium plated towel bars, and because of their many installation systems. City sanitary ware are available with slender toilet seats using the Quick Release mechanism and the Soft-Close closure system and they adopt the 4.5 litre Save Water discharge system.

# City

# Lavabi

## Washbasins

100x50  
**8823111**  
p.316



80x50  
**8822111**  
p.316



60x50  
**8831111**  
p.316



80x50  
**8856111**  
p.318



80x50  
**8857111**  
p.318



64x48  
**9131111**  
p.320



58x45  
**9130111**  
p.320



# Wc e Bidet

## Wc and Bidet

61x52  
**MASIAN111**  
p.322



57x47  
**MALISEON111**  
p.322



57x42  
**MVULCN11**  
p.324



52x35  
**911811**  
**9164111**  
p.326



52x35/F  
**911011**  
p.328



52x35  
**911411**  
**9162111**  
p.328



48x35  
**911911**  
**9169111**  
p.330





60x50 - 8831111



80x50 - 8822111

○ Bianco lucido  
Glossy white

---

100x50  
**8823111**



---





80x50  
**8822111**



---

60x50  
**8831111**



Dimensione Dimension (cm)	Componente Component	Descrizione Description	○ Cod.	Cm	Kg	317
100x50	<b>Lavabo</b> <b>Washbasin</b>	Lavabo con foro troppopieno monoforo predisposto per rubinetteria triforo. Installazione a sospensione ed incasso. Washbasin with overflow one taphole prearranged for three taphole fittings. Wall-hung and built-in installation.	○ 8823111	100x50 h19	23,2	
	<b>Portasciugamani</b> <b>Towel rail</b>	Portasciugamani in metallo cromato. Towel rail, in chromed metal.	PAPR100	-	0,6	
80x50	<b>Lavabo</b> <b>Washbasin</b>	Lavabo con foro troppopieno monoforo predisposto per rubinetteria triforo. Installazione a sospensione ed incasso. Washbasin with overflow one taphole prearranged for three taphole fittings. Wall-hung and built-in installation.	○ 8822111	80x50 h19	17,8	
	<b>Portasciugamani</b> <b>Towel rail</b>	Portasciugamani in metallo cromato. Towel rail, in chromed metal.	PAPR80	-	0,45	
60x50	<b>Lavabo</b> <b>Washbasin</b>	Lavabo con foro troppopieno monoforo predisposto per rubinetteria triforo. Installazione a sospensione ed incasso. Washbasin with overflow one taphole prearranged for three taphole fittings. Wall-hung and built-in installation.	○ 8831111	60x50 h19	14,8	
	<b>Portasciugamani</b> <b>Towel rail</b>	Portasciugamani in metallo cromato. Towel rail, in chromed metal.	PAPR60	-	0,4	
	<b>Piletta</b> <b>Drain</b>	Chiusura a scatto. Finitura cromo. Snap closure. Chrome finish.	PILL	1" 1/4	0,45	
	<b>Piletta in Ceramica</b> <b>Ceramic Drain</b>	Piletta con chiusura a scatto per lavabo con foro troppopieno, corpo in ottone e coperchio in ceramica. Drain with snap closure for basin with overflow, brass body and ceramic cover plate.	PCS11	-	0,65	
	<b>Sifone</b> <b>Siphon</b>	Sifone tondo in ottone cromato. Siphon round, in chromed brass.	MMBSIF	1" 1/4	1,3	
		Sifone tondo in abs cromato. Siphon round, in chromed abs.	MMBSIFC	1" 1/4	0,3	
	<b>Placca di chiusura</b> <b>Chromed plate</b>	Placca cromata per copertura del foro troppopieno. Chromed plate for overflow covering.	PCT	-	0,05	
	<b>Kit di fissaggio</b> <b>Fixing kit</b>	Kit fissaggio per lavabo sospeso (obbligatorio). Fixing kit for wall-hung washbasin (required).	FLAVABO	-	0,2	



80x50 - 8857111

○ Bianco lucido  
Glossy white

80x50  
**8856111**



80x50  
**8857111**





Dimensione Dimension (cm)	Componente Component	Descrizione Description	○ Cod.	Cm	Kg	319
80x50	<b>Lavabo Washbasin</b>	Lavabo con piano ceramico destro con foro troppopieno monoforo, predisposto per rubinetteria triforo. Installazione a sospensione o ad incasso. Washbasin with right ceramic top with overflow, one taphole prearranged for three taphole fittings. Wall-hung or built-in installation.	○ 8856111	80x50 h19	18	
	<b>Portasciugamani Towel rail</b>	Portasciugamani in metallo cromato. Towel rail, in chromed metal.	PAPR80DS	-	0,45	
80x50	<b>Lavabo Washbasin</b>	Lavabo con piano ceramico sinistro con foro troppopieno monoforo, predisposto per rubinetteria triforo. Installazione a sospensione o ad incasso. Washbasin with left ceramic top with overflow, one taphole prearranged for three taphole fittings. Wall-hung or built-in installation.	○ 8857111	80x50 h19	18	
	<b>Portasciugamani Towel rail</b>	Portasciugamani in metallo cromato. Towel rail, in chromed metal.	PAPR80DS	-	0,45	
	<b>Piletta Drain</b>	Chiusura a scatto. Finitura cromo. Snap closure. Chrome finish.	PILL	1" 1/4	0,45	
	<b>Piletta in Ceramica Ceramic Drain</b>	Piletta con chiusura a scatto per lavabo con foro troppopieno, corpo in ottone e coperchio in ceramica. Drain with snap closure for basin with overflow, brass body and ceramic cover plate.	PCS11	-	0,65	
	<b>Sifone Siphon</b>	Sifone tondo in ottone cromato. Siphon round, in chromed brass.	MMBSIF	1" 1/4	1,3	
		Sifone tondo in abs cromato. Siphon round, in chromed abs.	MMBSIFC	1" 1/4	0,3	
	<b>Placca di chiusura Chromed plate</b>	Placca cromata per copertura del foro troppopieno. Chromed plate for overflow covering.	PCT	-	0,05	
	<b>Kit di fissaggio Fixing kit</b>	Kit fissaggio per lavabo sospeso (2 kit obbligatori). Fixing kit for wall-hung washbasin (2 kits required).	FLAVABO	-	0,2	



58x45 - 9130111



64x48 - 9131111



64x48 - 9131111

○ Bianco lucido  
Glossy white

---

64x48  
**9131111**



---

58x45  
**9130111**



Dimensione Dimension (cm)	Componente Component	Descrizione Description	○ Cod.	Cm	Kg	321
64x48	<b>Lavabo</b> <b>Washbasin</b>	Lavabo con foro troppopieno monoforo predisposto per rubinetteria triforo. Installazione a sospensione e incasso. Washbasin with overflow one taphole, prearranged for three taphole fittings. Wall-hung, built-in installation.	○ 9131111	64x48 h18,5	13	
58x45	<b>Lavabo</b> <b>Washbasin</b>	Lavabo con foro troppopieno monoforo predisposto per rubinetteria triforo. Installazione a sospensione e incasso. Washbasin with overflow one taphole, prearranged for three taphole fittings. Wall-hung, built-in installation.	○ 9130111	58x45 h18,5	-	
	<b>Colonna</b> <b>Pedestal</b>	Colonna in ceramica. Ceramic pedestal.	807411	Ø18 h69	12,4	
	<b>Piletta</b> <b>Drain</b>	Chiusura a scatto. Finitura cromo. Snap closure. Chrome finish.	PILL	1" 1/4	0,45	
	<b>Piletta in Ceramica</b> <b>Ceramic Drain</b>	Piletta con chiusura a scatto per lavabo con foro troppopieno, corpo in ottone e coperchio in ceramica. Drain with snap closure for basin with overflow, brass body and ceramic cover plate.	PCS11	-	0,65	
	<b>Sifone</b> <b>Siphon</b>	Sifone tondo in ottone cromato. Siphon round, of chromed brass.	MMBSIF	1" 1/4	1,3	
		Sifone tondo in abs cromato. Siphon round, in chromed abs.	MMBSIFC	1" 1/4	0,3	
	<b>Placca di chiusura</b> <b>Chromed plate</b>	Placca cromata per copertura del foro troppopieno. Chromed plate for overflow covering.	PCT	-	0,05	
	<b>Kit di fissaggio</b> <b>Fixing kit</b>	Kit fissaggio per lavabo sospeso (obbligatorio). Fixing kit for wall-hung washbasin (required).	FLAVABO	-	0,2	



57x47 - MALISEON111



○ Bianco lucido  
Glossy white

61x52  
**MASIAN111**



57x47  
**MALISEON111**



Dimensione Dimension (cm)	Componente Component	Descrizione Description	○ Cod.	Cm	Kg	323
61x52	<b>Lavabo</b> <b>Washbasin</b>	Lavabo con foro troppopieno monoforo, predisposto per rubinetteria triforo. Installazione ad incasso. Washbasin with overflow, one taphole prearranged for three taphole fittings. Built-in installation.	○ MASIAN111	61x52 h15,5	9,7	
57x47	<b>Lavabo</b> <b>Washbasin</b>	Lavabo con foro troppopieno monoforo, predisposto per rubinetteria triforo. Installazione ad incasso. Washbasin with overflow, one taphole prearranged for three taphole fittings. Built-in installation.	○ MALISEON111	57x47 h20,5	8,4	
	<b>Piletta</b> <b>Drain</b>	Chiusura a scatto. Finitura cromo. Snap closure. Chrome finish.	PILL	1" 1/4	0,45	
	<b>Piletta in Ceramica</b> <b>Ceramic Drain</b>	Piletta con chiusura a scatto per lavabo con foro troppopieno, corpo in ottone e coperchio in ceramica. Drain with snap closure for basin with overflow, brass body and ceramic cover plate.	PCS11	-	0,65	
	<b>Placca di chiusura</b> <b>Chromed plate</b>	Placca cromata per copertura del foro troppopieno. Chromed plate for overflow covering.	PCT	-	0,05	





57x42 - MVULCN11

Bianco lucido  
Glossy white

57x42  
**MVULCN11**



Dimensione Dimension (cm)	Componente Component	Descrizione Description	○ Cod.	Cm	Kg	325
57x42	<b>Lavabo</b> <b>Washbasin</b>	Lavabo con foro troppopieno predisposto per rubinetteria da parete o su piano. Installazione a sottopiano. (fissaggio incluso). Washbasin with overflow, prearranged for wall or countertop tap fittings. Under-counter installation. (fixing screw included).	○ MVULCN11	57x42 h20	8,5	
	<b>Piletta</b> <b>Drain</b>	Chiusura a scatto. Finitura cromo. Snap closure. Chrome finish.	PILL	1" 1/4	0,45	
	<b>Piletta in Ceramica</b> <b>Ceramic Drain</b>	Piletta con chiusura a scatto per lavabo con foro troppopieno, corpo in ottone e coperchio in ceramica. Drain with snap closure for basin with overflow, brass body and ceramic cover plate.	PCS11	-	0,65	
	<b>Placca di chiusura</b> <b>Chromed plate</b>	Placca cromata per copertura del foro troppopieno. Chromed plate for overflow covering.	PCT	-	0,05	



52x35 - 911811 - 9164111

○ Bianco lucido  
Glossy white

52x35  
**911811**  
**9164111**



**save water**





**quickrelease**



**softclose**



Dimensione Dimension (cm)	<b>Componente</b> <b>Component</b>	Descrizione Description	○ Cod.	Cm	Kg
52x35	<b>Wc sospeso</b> <b>Wall-hung wc</b>	Wc installazione a sospensione con sistema di fissaggio dal basso. Wall-hung wc installation with concealed fixing.	○ 911811	52x35	19
	<b>Bidet sospeso</b> <b>Wall-hung bidet</b>	Bidet sospeso monoforo con foro troppopieno e sistema di fissaggio dal basso. Single hole wall-hung bidet with overflow and concealed fixing.	○ 9164111	52x35	15,2
	<b>Sedile "soft-close"</b> <b>Seat &amp; cover "soft-close"</b>	Sedile "Soft-Close" in resina termoindurente. Seat & Cover "Soft-Close", in thermosetting resin.	MS91C11	-	1,9
	<b>Sedile</b> <b>Seat &amp; cover</b>	Sedile in resina termoindurente. Seat & Cover, in thermosetting resin.	MS91111	-	1,9
	<b>Piletta</b> <b>Drain</b>	Chiusura a scatto. Finitura cromo. Snap closure. Chrome finish.	PILL	1" 1/4	0,45
	<b>Piletta in Ceramica</b> <b>Ceramic Drain</b>	Piletta con chiusura a scatto per lavabo con foro troppopieno, corpo in ottone e coperchio in ceramica. Drain with snap closure for basin with overflow, brass body and ceramic cover plate.	PCS11	-	0,65
	<b>Protezione</b> <b>Protection</b>	Protezione insonorizzante per wc o bidet sospeso. Soundproof protection for wall-hung wc or bidet.	MPR	-	-
	<b>Staffe di fissaggio</b> <b>Fixing brackets</b>	Staffe di fissaggio per wc o bidet. Fixing brackets for wc or bidet.	FSOSP	-	3,8
	<b>Fissaggio rapido</b> <b>Quick fixing screw</b>	Fissaggio a scomparsa dal basso (obbligatorio 1 kit per articolo) Concealed fixing (1 kit required per article)	FISR2	-	0,3



52x35F - 911011 - 9162111

○ Bianco lucido  
Glossy white

52x35/F  
**911011**  
**9162111**



52x35  
**911411**  
**9162111**



Solo per  
Only for  
911011

Solo per  
Only for  
911411



**swirlflush®**









**save water**



**quickrelease**



**softclose**

Dimensione Dimension (cm)	Componente Component	Descrizione Description	○ Cod.	Cm	Kg
52x35/F	<b>Wc</b> <b>Wc</b>	* Wc predisposto per scarico a parete oppure a pavimento ** tramite curva tecnica, con sistema di scarico <b>Swirflush®</b> . Wall wc with or floor outlet (through pipe fitting), with <b>Swirflush®</b> system.	○ 911011	52x35	
52x35	<b>Wc</b> <b>Wc</b>	Wc predisposto per scarico a parete oppure a pavimento tramite curva tecnica. Wall wc with or floor outlet (through pipe fitting).	○ 911411	52x35	25
	<b>Bidet</b> <b>Bidet</b>	Bidet monoforo con foro troppopieno. One taphole bidet with overflow hole.	○ 9162111	52x35	20
	<b>Sedile "soft-close"</b> <b>Seat &amp; cover</b> <b>"soft-close"</b>	Sedile "Soft-Close" in resina termoindurente. Seat & Cover "Soft-Close", in thermosetting resin.	MS91C11	-	1,9
	<b>Sedile</b> <b>Seat &amp; cover</b>	Sedile in resina termoindurente. Seat & Cover, in thermosetting resin.	MS91111	-	1,9
	<b>Piletta</b> <b>Drain</b>	Chiusura a scatto. Finitura cromo. Snap closure. Chrome finish.	PILL	1" 1/4	0,45
	<b>Piletta in Ceramica</b> <b>Ceramic Drain</b>	Piletta con chiusura a scatto per lavabo con foro troppopieno, corpo in ottone e coperchio in ceramica. Drain with snap closure for basin with overflow, brass body and ceramic cover plate.	PCS11	-	0,65
	<b>Curva tecnica</b> <b>Technical curve</b>	Curva tecnica. Technical curve.	MCURVA	ø11	0,35
		Kit fissaggio curva. Fixing kit curve.	FISC	-	0,2
	<b>Curva tecnica a 90</b> <b>Technical curve</b> <b>at 90</b>	Curva tecnica a 90° per wc e wc monoblocco con fissaggio. Technical curve at 90° for cc pans with fixing included.	MCURVA90	ø11	0,9
	<b>Kit di fissaggio</b> <b>Fixing screw</b>	Kit di fissaggio orizzontale per wc o bidet. Finitura cromo e bianco. Consigliato. Fixing screw horizontal for wc or bidet. Chrome and white finish. Recommended.	FVB	-	0,1

\*Non è consigliato l'impiego di cassette di scarico esterne o impianti dotati di rubinetto flussometro.  
We do not recommend the use of external flushing cisterns or systems endowed with flushometer valves.

\*\*Disponibile da luglio 2019  
Available from July 2019



48x35 - 911911 - 9169111

○ Bianco lucido  
Glossy white







48x35  
**911911**  
**9169111**



  
**save water**

  
**quickrelease**

  
**softclose**

Dimensione Dimension (cm)	Componente Component	Descrizione Description	○ Cod.	Cm	Kg	331
48x35	<b>Wc</b> <b>Wc</b>	Wc predisposto per scarico a parete oppure a pavimento tramite curva tecnica. Wall wc with or floor outlet (through pipe fitting).	○ 911911	48x35		
	<b>Bidet</b> <b>Bidet</b>	Bidet monoforo con foro troppopieno. One taphole bidet with overflow hole.	○ 9169111	48x35		
	<b>Sedile "soft-close"</b> <b>Seat &amp; cover</b> <b>"soft-close"</b>	Sedile "Soft-Close" in resina termoindurente. Seat & Cover "Soft-Close", in thermosetting resin.	MS91C11	-	1,9	
	<b>Sedile</b> <b>Seat &amp; cover</b>	Sedile in resina termoindurente. Seat & Cover, in thermosetting resin.	MS9111	-	1,9	
	<b>Piletta</b> <b>Drain</b>	Chiusura a scatto. Finitura cromo. Snap closure. Chrome finish.	PILL	1" 1/4	0,45	
	<b>Piletta in Ceramica</b> <b>Ceramic Drain</b>	Piletta con chiusura a scatto per lavabo con foro troppopieno, corpo in ottone e coperchio in ceramica. Drain with snap closure for basin with overflow, brass body and ceramic cover plate.	PCS11	-	0,65	
	<b>Curva tecnica</b> <b>Technical curve</b>	Curva tecnica. Technical curve.	MCURVA	ø 11	0,35	
		Kit fissaggio curva. Fixing kit curve.	FISC	-	0,2	
	<b>Curva tecnica a 90</b> <b>Technical curve</b> <b>at 90</b>	Curva tecnica a 90° per wc e wc monoblocco con fissaggio. Technical curve at 90° for cc pans with fixing included.	MCURVA90	ø11	0,9	
	<b>Kit di fissaggio</b> <b>Fixing screw</b>	Kit di fissaggio orizzontale per wc o bidet. Finitura cromo e bianco. Consigliato. Fixing screw horizontal for wc or bidet. Chrome and white finish. Recommended.	FVB	-	0,1	



# Lavabi Washbasins

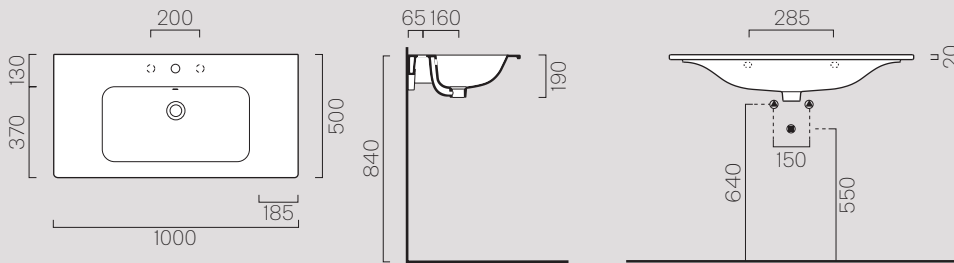

100x50  
**8823111**

Description	Washbasin
Code	<b>8823111</b>
Dimensions	100x50 h19
Weight	Kg 23,2
Capacity	Lt 9
Overflow	CL 25
Installation	wall-hung, built-in
Taphole	1(3)

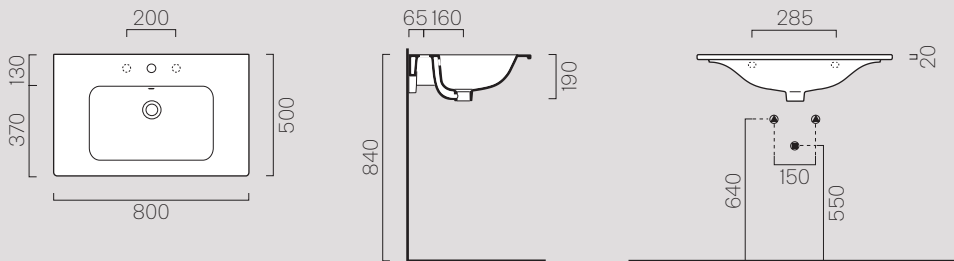

80x50  
**8822111**

Description	Washbasin
Code	<b>8822111</b>
Dimensions	80x50 h19
Weight	Kg 17,8
Capacity	Lt 8,5
Overflow	CL 25
Installation	wall-hung, built-in
Taphole	1(3)

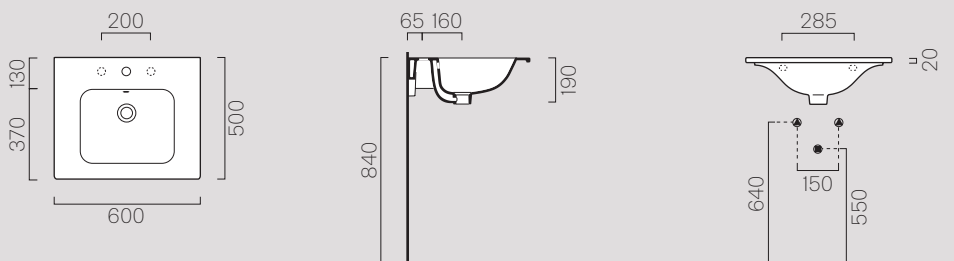

60x50  
**8831111**

Description	Washbasin
Code	<b>8831111</b>
Dimensions	60x50 h19
Weight	Kg 14,8
Capacity	Lt 6
Overflow	CL 25
Installation	wall-hung, built-in
Taphole	1(3)

80x50

**8856111**

Description	Washbasin
Code	<b>8856111</b>
Dimensions	80x50 h19
Weight	Kg 18
Capacity	Lt 6,5
Overflow	CL 25
Installation	wall-hung, built-in
Taphole	1 (3)

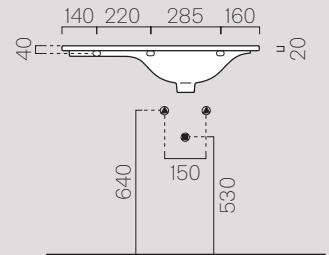
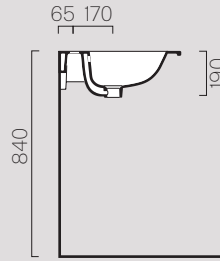
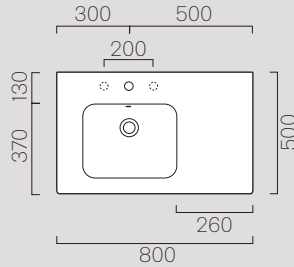

Vista dal retro.  
View from the back.

80x50

**8857111**

Description	Washbasin
Code	<b>8857111</b>
Dimensions	80x50 h19
Weight	Kg 18
Capacity	Lt 6,5
Overflow	CL 25
Installation	wall-hung, built-in
Taphole	1 (3)

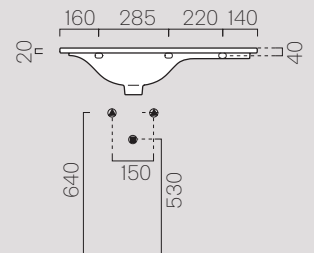
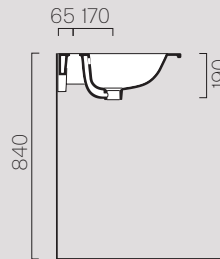
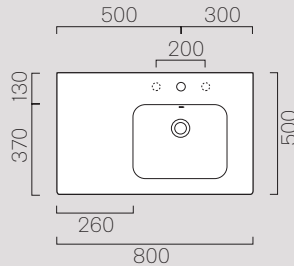

Vista dal retro.  
View from the back.

64x48

**9131111**

Description	Washbasin
Code	<b>9131111</b>
Dimensions	64x48 h18,5
Weight	Kg 13
Capacity	Lt 8
Overflow	CL 25
Installation	wall-hung, built-in
Taphole	1 (3)

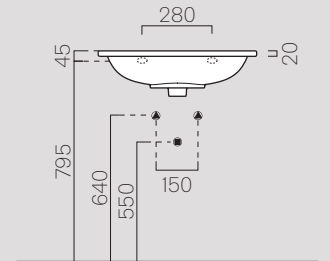
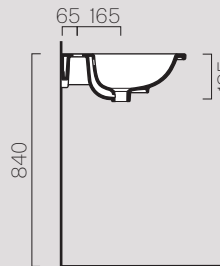
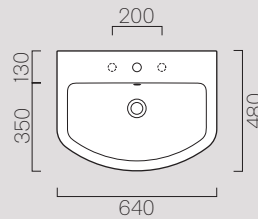

58x45

**9130111**

Description	Washbasin
Code	<b>9130111</b>
Dimensions	58x45 h18,5
Overflow	CL 25
Installation	wall-hung, built-in
Taphole	1 (3)

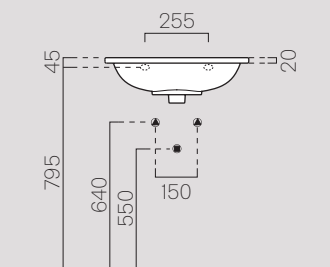
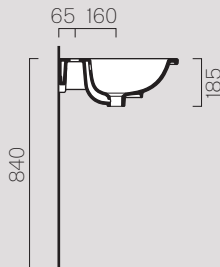
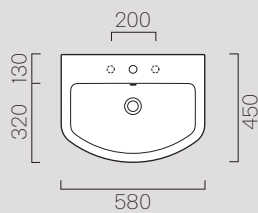



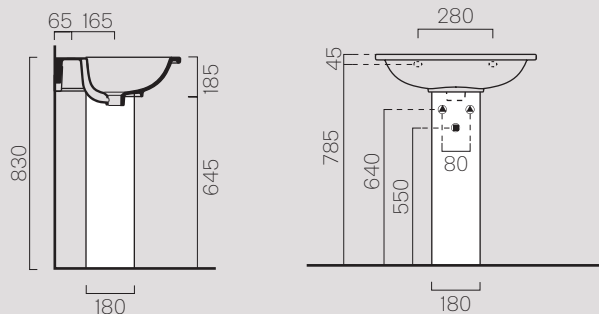

Description	Pedestal
Code	<b>807411</b>
Dimensions	Ø18 h69
Weight	Kg 12,4
Installation	floor

61x52  
**MASIAN111**

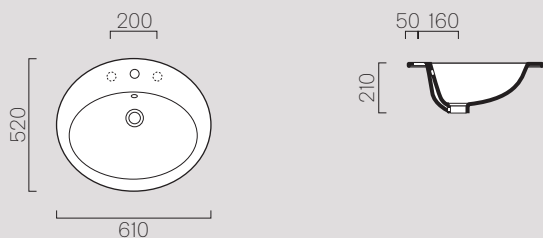

Description	Washbasin
Code	<b>MASIAN111</b>
Dimensions	61x52
Weight	Kg 9,7
Capacity	Lt 8,5
Overflow	CL 25
Installation	built-in
Taphole	1(3)

57x47  
**MALISEON111**

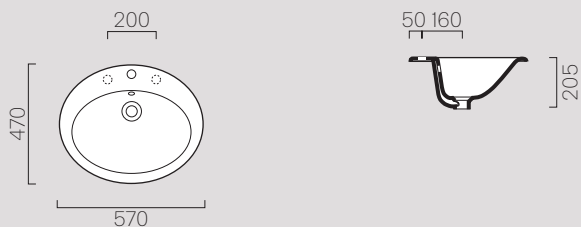

Description	Washbasin
Code	<b>MALISEON111</b>
Dimensions	57x47
Weight	Kg 8,4
Capacity	Lt 4,5
Overflow	CL 25
Installation	built-in
Taphole	1(3)

57x42  
**MVULCN11**



Description	Washbasin
Code	<b>MVULCN11</b>
Dimensions	57x42
Weight	Kg 7
Capacity	Lt 7
Overflow	CL 25
Installation	built-in
Taphole	0

# Wc e Bidet

## Wc and Bidet

52x35

**911811**

Description	Wc
Code	<b>911811</b>
Dimensions	52x35
Weight	Kg 19
Flush system	standard
Installation	wall-hung

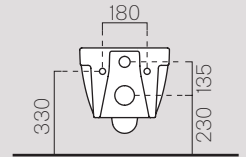
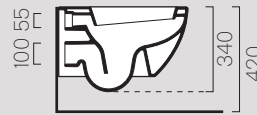
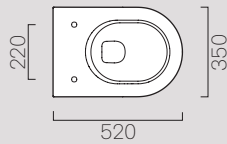

52x35

**916411**

Description	Bidet
Code	<b>916411</b>
Dimensions	52x35
Weight	Kg 15,2
Overflow	CL 25
Installation	wall-hung
Taphole	1

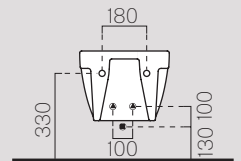
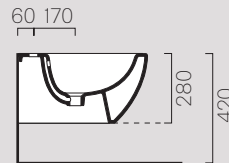
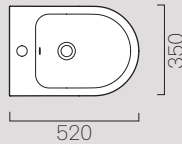

52x35

**911411**

Description	Wc
Code	<b>911411</b>
Dimensions	52x35
Weight	Kg 25
Flush system	standard
Installation	floor outlet

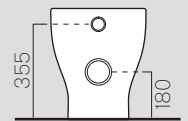
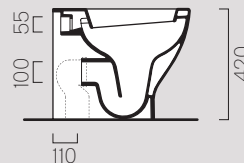
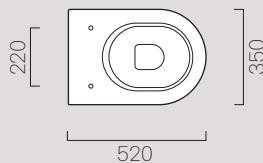

**Curva tecnica**  
Technical curve

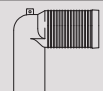

**Codice**  
Codes

MCURVA

MCURVAS

MCURVA90

**Interasse**  
Distance

\* 110

\* 160

\* 70

## 52x35 9162111

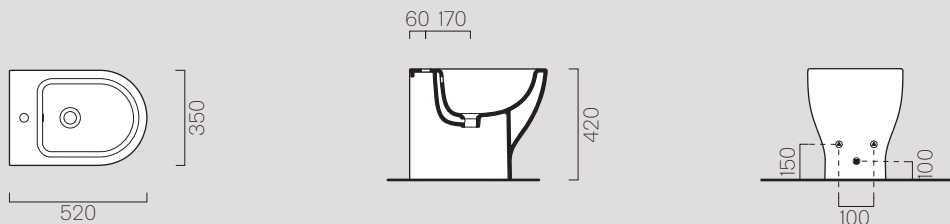

Description	Bidet
Code	<b>9162111</b>
Dimensions	52x35
Weight	Kg 20
Overflow	CL 25
Installation	floor outlet
Taphole	1

## 52x35/F 911011

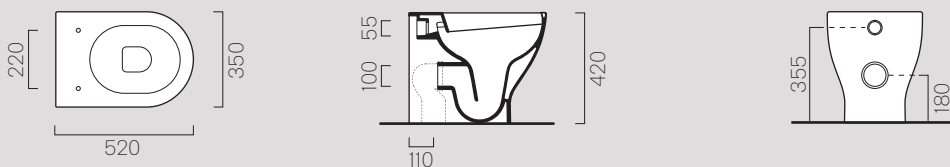

Description	Wc
Code	<b>911011</b>
Dimensions	52x35
Weight	Kg
Flush system	swirlflush
Installation	floor outlet

**Non è consigliato l'impiego di cassette di scarico esterne o impianti dotati di rubinetto flussometro.**  
 We do not recommend the use of external flushing cisterns or systems endowed with flushometer valves.

## 48x35 911911

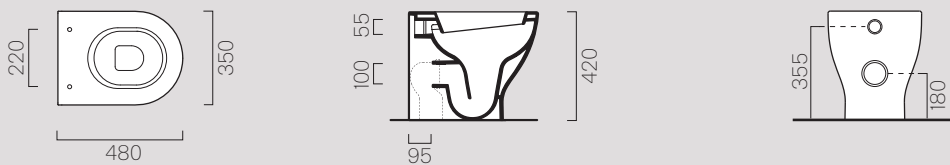

Description	Wc
Code	<b>911911</b>
Dimensions	48x35
Weight	Kg 22,5
Flush system	standard
Installation	floor outlet

## 48x35 9169111

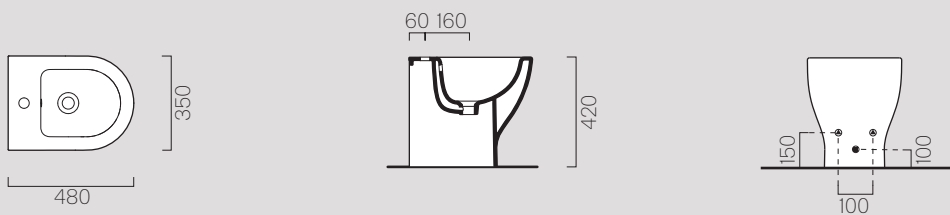

Description	Bidet
Code	<b>9169111</b>
Dimensions	48x35
Weight	Kg 20
Overflow	CL 25
Installation	floor outlet
Taphole	1

